

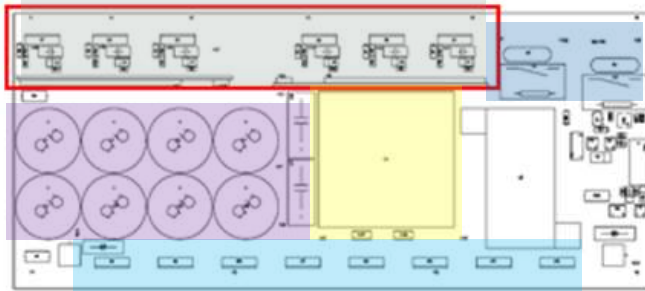

# Tf01 and tf02 advanced design of welding machines

---

# Improvement at system level

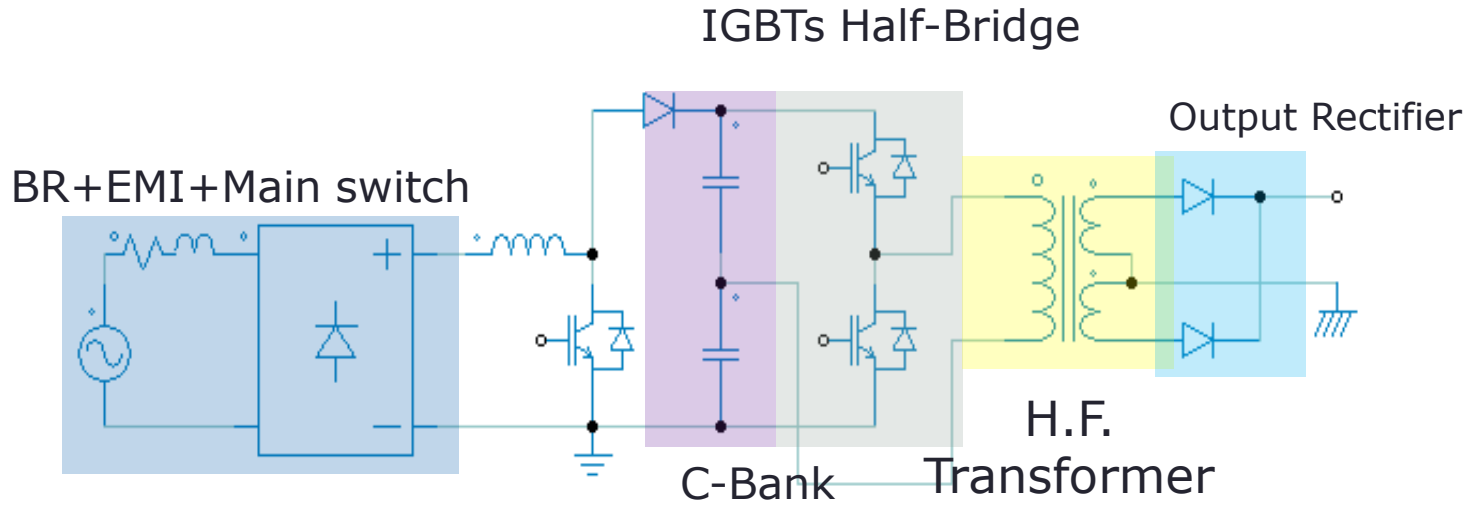

Typical machine



New Desing TF01

- Measurement of thermal performance on Typical Commercial welding machine,  $f_{sw}=38\text{kHz}$ ,  $I_{out}=200\text{A}$

- Acceptance criteria:  $\Delta V_{CE(max)} < 160\text{V}$

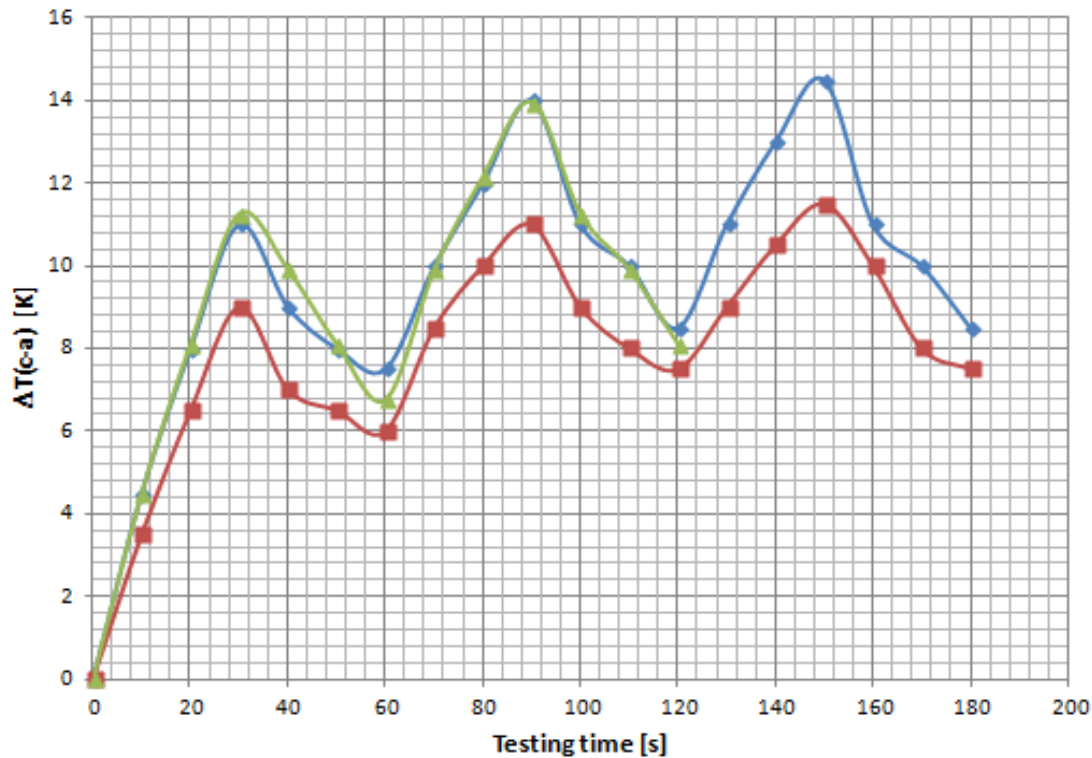
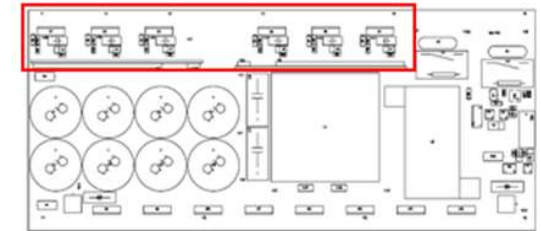

# New Design with $L_s < 80\text{nH}$ at Board level

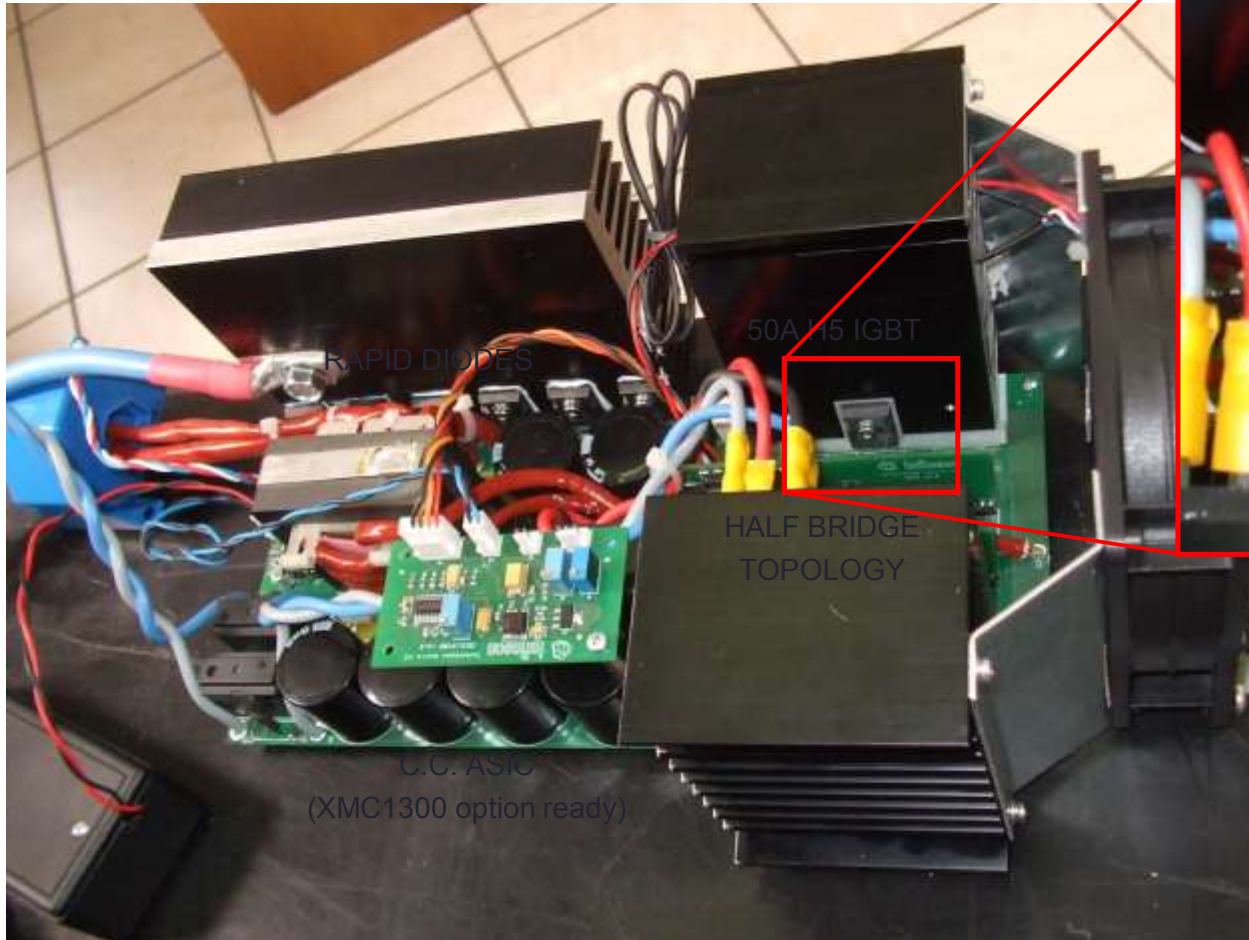

Drive card with 1ED-Eco

# Test Results with New Design

- Measurement of thermal performance on New Design TF01
  - Acceptance criteria:  $\Delta V_{CE(max)} < 160V$

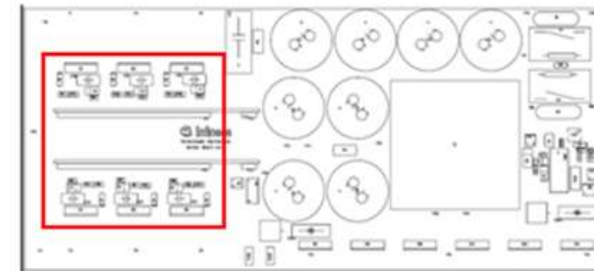
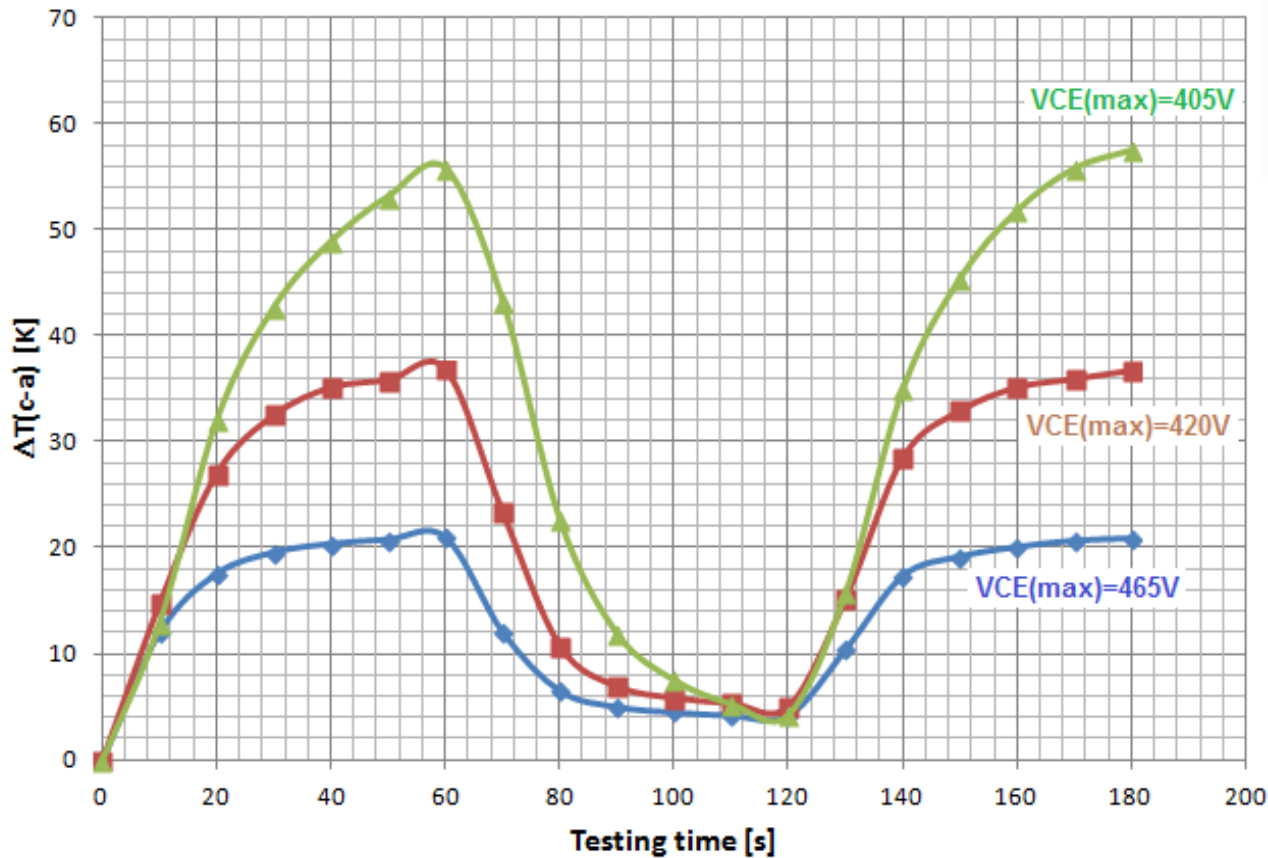

- ◆ 40N65H5
- 40N60H3
- ▲ 40N60T



# TF02 Design Improvements

- 1xIKW50N65H5 in place of 2x40A Competitors' IGBTs.
- Dimensions down to 35% possible
- Weight down to 30% possible
- Possible to use half of the Electrolytic capacitors.
- Switching frequency up to 100kHz.
- Reduction of transformer size.
- Digital control available.
- Isolated drivers available.



**TF02 design having  
Ls < 60nH**